

Instruction Manual

Installation • Operation • Maintenance



Voltage Regulator AVR R250

Ruitai industry Co.,Ltd.
Tel: +86 577 56784310
Fax: +86 577 56667563
Email: sales@china-avr.com
www.china-avr.com

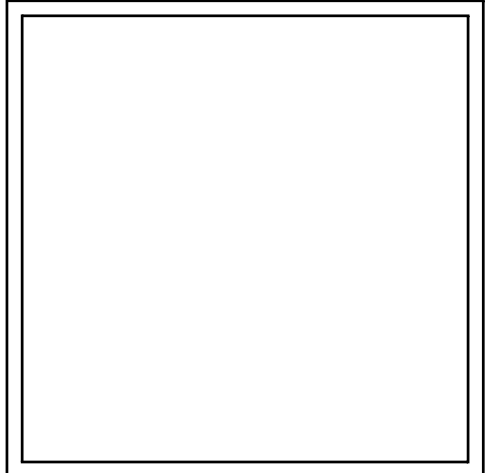

*This manual is to be given to
the end user*

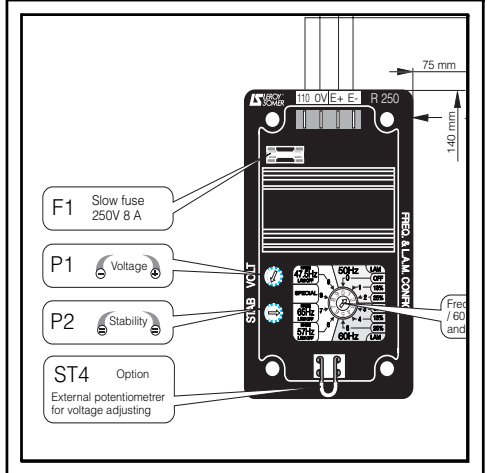

R250

A.V.R.

Installation and maintenance

R250
A.V.R.

This manual concerns the alternator A.V.R. which you have just purchased.

We wish to draw your attention to the contents of this maintenance manual. By following certain important points during installation, use and servicing of your A.V.R., you can look forward to many years of trouble-free operation.

SAFETY MEASURES

Before using your machine for the first time, it is important to read the whole of this installation and maintenance manual.

All necessary operations and interventions on this machine must be performed by a qualified technician.

Our technical support service will be pleased to provide any additional information you may require.

The various operations described in this manual are accompanied by recommendations or symbols to alert the user to potential risks of accidents. It is vital that you understand and take notice of the following warning symbols.

WARNING

Warning symbol for an operation capable of damaging or destroying the machine or surrounding equipment.



Warning symbol for general danger to personnel.



Warning symbol for electrical danger to personnel.

Note : LEROY-SOMER reserves the right to modify the characteristics of its products at any time in order to incorporate the latest technological developments.

The information contained in this document may therefore be changed without notice.

R250 A.V.R.

SUMMARY

| | |
|--|-----------|
| 1 - SUPPLY | 4 |
| 1.1 - SHUNT excitation system..... | 4 |
| 2 - R250 A.V.R. | 5 |
| 2.1 - Characteristics | 5 |
| 2.2 - U/F fonction and LAM | 5 |
| 2.3 - R250 A.V.R. option | 5 |
| 2.4 - LAM Characteristics | 6 |
| 2.5 - Typical effects of the LAM | 7 |
| 3 - INSTALLATION - COMMISIONING | 8 |
| 3.1 - Electrical checks on the AVR..... | 8 |
| 3.2 - Settings..... | 8 |
| 3.3 - Electrical faults..... | 9 |
| 4 - SPARE PARTS | 10 |
| 4.1 - Designation..... | 10 |
| 4.2 - Technical support service..... | 10 |



Any maintenance or breakdown operations on the A.V.R. are to be done by personnel trained on commisioning, servicing and maintenance for the electrical and mechanical elements.

Copyright 2005: MOTEURS LEROY-SOMER

This document is the property of:

MOTEURS LEROY SOMER.

It may not be reproduced in any form without prior authorization

All brands and models have been registered and patents applied for.

R250 A.V.R.

1 - SUPPLY

1.1 - SHUNT excitation system

The SHUNT excitation alternator is auto-excited with a R 250 voltage regulator.

The regulator controls the excitation current according to the alternator's output voltage. With a very simple conception, the SHUNT excitation alternator does not have a short circuit capacity.

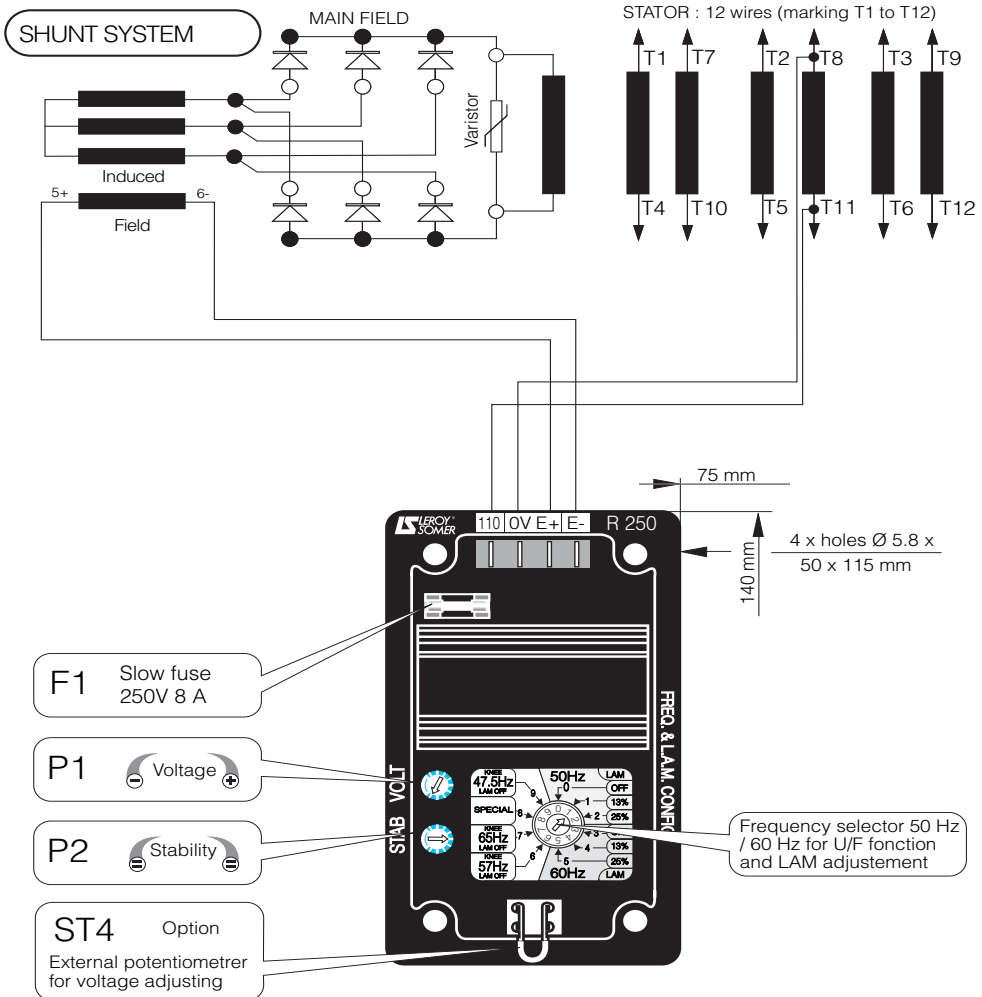

R250

A.V.R.

2 - R250 A.V.R.

2.1 - Characteristics

- Voltage regulation: around $\pm 0,5\%$.
- Supply range/voltage detection 85 to 139 V (50/60Hz).
- Rapid response time (500 ms) for a transient voltage variation amplitude of $\pm 20\%$.
- Voltage setting **P1**.
- Stability setting **P2**.
- Supply protected with an 8 A fuse, slow action (supports 10 A for 10 s).

2.2 - U/F Fonction and LAM

The threshold position (50 Hz - 60 Hz) to action the U/F fonction as well as the LAM setting type is selected using the potentiometer.

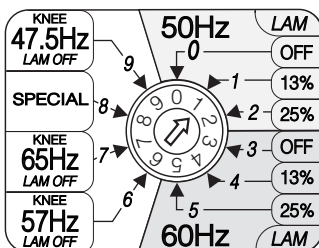

WARNING: The jumper settings must correspond to the rated operating frequency (see the nameplate on the alternator).

Risk of destruction for the alternator.

The threshold position and LAM fonction settings are done with the jumper.

Operating at 50 Hz: (U/F gradient)

0: threshold at 48 Hz without LAM for impacts between 30 and 40% of the rated load.

1: threshold at 48 Hz with LAM 13% for impacts between 40 and 70% of the rated load.

2: threshold at 48 Hz with LAM 25% for impacts > 70% of the rated load.

Operating at 60 Hz: (U/F gradient)

3: threshold at 58 Hz without LAM for impacts between 30 and 40% of the rated load.

4: threshold at 58Hz with LAM 13% for impacts 40 and 70% of the rated load.

5: threshold at 58Hz with LAM 25% for impacts > 70% of the rated load.

Specific operating

6: threshold at 57Hz without LAM for speed variations at a steady state > 2 Hz

7: threshold at 65Hz without LAM for variable speed and tractelec / gearlec (U/F gradient).

8: special: the factory setting 48Hz 2U/F gradient ; a special programme is possible on request. This programme must be specified before ordering, during the project study.

9: threshold at 47.5 Hz without LAM for speed variations at a steady state > 2 Hz

2.3 - R250 A.V.R. option

Potentiometer for voltage setting, 1000 Ω / 0,5 W min: setting range $\pm 5\%$.

- Remove the **ST4** jumper.

R250 A.V.R.

2.4 - LAM characteristics (Load Acceptance Module)

2.4.1 - Voltage drop

The LAM system is integrated in the A.V.R. It is active as standard. It can be adjusted to 13% or 25%.

- Role of the «LAM» (Load Adjustment Module):

On application of a load, the rotation speed of the generator set decreases. When it passes below the preset frequency threshold, the LAM causes the voltage to drop by approximately 13% or 25% and consequently the amount of active load applied is reduced by approximately 25% to 50%, until the speed reaches its rated value again.

Hence the "LAM" can be used either to reduce the speed variation (frequency) and its duration for a given applied load, or to increase the applied load possible for one speed variation (turbo-charged engines). To avoid voltage oscillations, the trip threshold for the "LAM" function should be set approximately 2 Hz below the lowest frequency in steady state.

It is advised to use the "LAM" at 25% for load impacts > at 70% of the genset rated power.

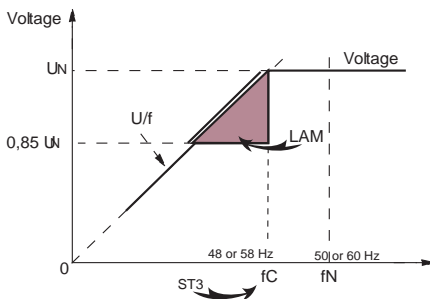

2.4.2 - Gradual voltage return function

During load impacts, the function helps the genset to return to its rated speed faster thanks to a gradual increase in voltage according to the following principles:

- if the speed drops between 46 Hz and 50 Hz, the rated voltage follows a fast gradient as it is restored.

- if the speed drops below 46 Hz, since the engine needs more help, the voltage follows a slow gradient as it returns to the reference value.

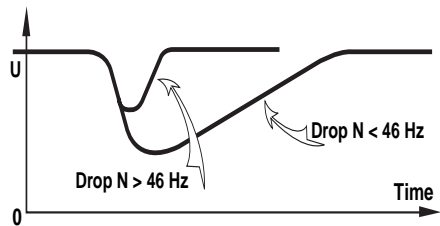

R250 A.V.R.

2.5 - Typical effects of the LAM with a diesel engine or without a LAM (U/F only)

2.5.1 - Voltage

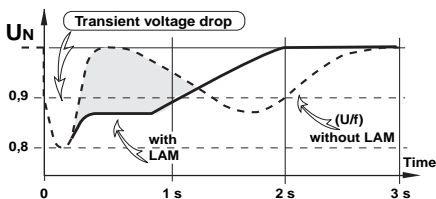

2.5.2 - Frequency

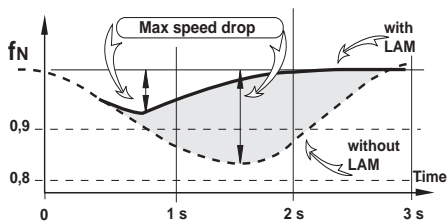

2.5.3 - Power

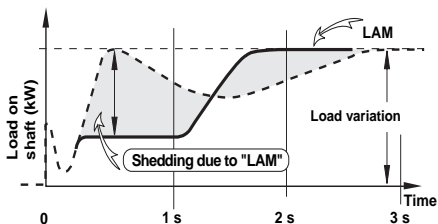

R250 A.V.R.

3 - INSTALLATION - COMMISSIONING

3.1 - Electrical checks on the AVR

- Check that all connections have been made properly as shown in the attached wiring diagram.
- Check that the position of the jumper corresponds to the operating frequency.
- Check whether the ST4 jumper or the remote adjustment potentiometer have been connected.

3.2 - Settings



The different settings made during the trial are to be done by qualified personnel. Respecting the load speed specified on the nameplate is vital in order to start a settings procedure. After operational testing, replace all access panels or covers.

The only possible settings on the machine are to be done with the A.V.R.

3.2.1 - R250 settings (SHUNT system)

Initial potentiometer positions

- voltage setting potentiometer P1 for the A.V.R.: full left
- remote voltage setting potentiometer: in the middle.

Operate the alternator at its rated speed: if the voltage does not rise it is necessary to re-magnetise the magnetic circuit.

- slowly adjust the voltage potentiometer of the A.V.R. P1 until the output voltage reaches its rated value.
- Stability setting with P2.

3.2.2 - Special type of use

WARNING

Excitation circuit E+, E- must not be left open when the machine is running: A.V.R. damage will occur.

3.2.2.1 - R250 field weakening (SHUNT)

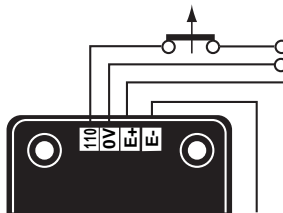

The exciter is switched off by disconnecting the A.V.R. power supply (1 wire - 0 or 110V). Contact rating: 16A - 250V AC

3.2.2.2 - R250 field forcing

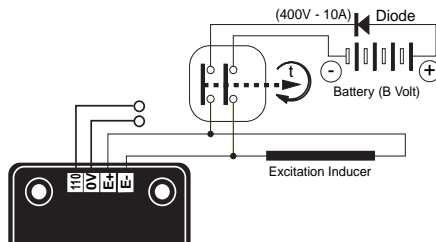

The battery must be isolated from the mass.



Exciter field may be at line potential.

R250
A.V.R.

3.3 - Electrical faults

| Fault | Action | Effect | Check/cause |
|---|--|--|--|
| No voltage at no load on start-up | Connect a new battery of 4 to 12 volts to terminals E- and E+ respecting the polarity for 2 to 3 seconds | The alternator starts up and its voltage is still correct when the battery is removed. | - Lack of residual magnetism |
| | | The alternator starts up but its voltage does not reach the rated value when the battery is removed. | - Check the connection of the voltage reference to the A.V.R. - Faulty diodes - Induced short circuit |
| | | The alternator starts up but its voltage disappears when the battery is removed | - Faulty A.V.R. - Exciter field short-circuited - Short-circuit in the main field. Check the resistance |
| Voltage too low | Check the drive speed | Correct speed | Check the A.V.R. connections (A.V.R. may be faulty) - Field windings short-circuited - Rotating diodes burnt out - Main field winding short-circuited - Check the resistance |
| | | Speed too low | Increase the drive speed (Do not touch the A.V.R. pot (P1) before returning to the correct speed.) |
| Voltage too high | Adjust A.V.R. potentiometer | Adjustment ineffective | - Faulty A.V.R. - 1 faulty diode |
| Voltage oscillations | Adjust A.V.R. stability potentiometer | | - Check the speed: possibility of cyclic irregularity - Loose terminals - Faulty A.V.R. - Speed too low on load (or U/F gradient set too high) |
| Voltage correct at no load and too low when on load (*) | Run at no load and check the voltage between E+ and E- on the A.V.R. | | - Check the speed (or U/F gradient set too high) - Faulty rotating diodes - Short-circuit in the main field. Check the resistance - Faulty induced excitation |
| | | | |
| (*) Warning: For single-phase operation, check that the sensing wires coming from the A.V.R. are correctly connected to the operating terminals (see the alternator manual). | | | |
| Voltage disappears during operation | Check the A.V.R., the surge suppressor, the rotating diodes and replace any defective components | The voltage does not return to the rated value. | - Exciter winding open circuit - Faulty induced excitation - Faulty A.V.R. - Main field open circuit or short-circuited |



Warning: after setting-up or trouble-shooting, replace all access panels or covers.

R250
A.V.R.**4 - SPARE PARTS****4.1 - Designation**

| Description | Type | Code |
|-------------|-------|----------------|
| A.V.R. | R 250 | AEM 110 RE 019 |

4.2 - Technical support service

Our technical support service will be pleased to help you with any information needed.

For replacement part orders, it is necessary to indicate the type and the code number of the A.V.R.

Please contact your usual correspondent.

An extensive network of service centres is available to rapidly supply any necessary parts.

In order to ensure the correct operation and safety of our machines, we strongly recommend that original manufacturer's spare parts are used.

Failure to do so, will discharge the manufacturer from liability in the case of damage.

R250
A.V.R.



MOTEURS LEROY-SOMER 16015 ANGOULÊME CEDEX -

FRANCE

338 567 258 RCS ANGOULÊME
S.A. au capital de 62 779 000 €